

PARTS LIST

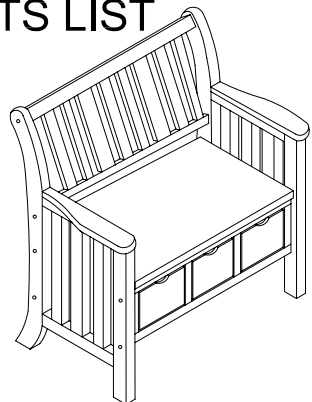

A. Left & Right Armrest 1Set

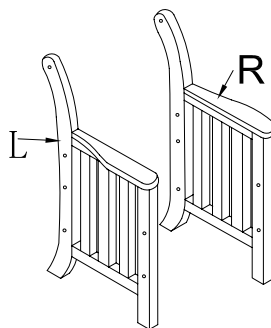

B. Back Seat Bench Panel 1pcs

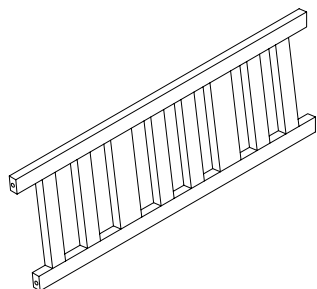

C. Side Storage Apron 2pcs

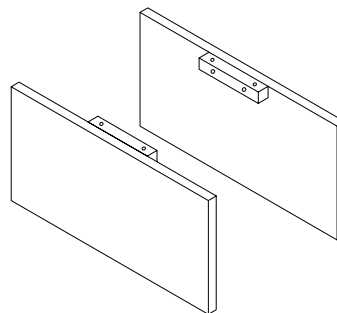

D. Rear Storage Apron

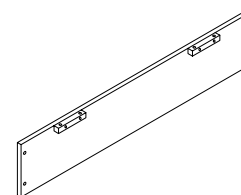

E. Front Storage Apron

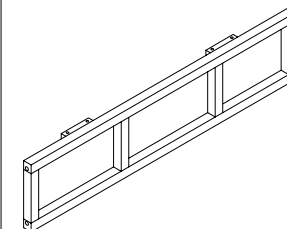

F. Seat Storage Panel 1pcs

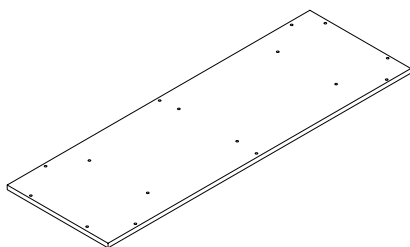

G. Drawer Glider 3pcs

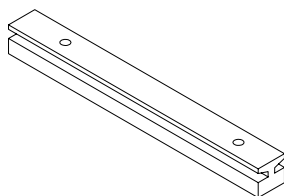

H. Rear Drawer Panel 3pcs

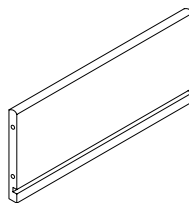

L. Bottom Drawer Panel 3pcs

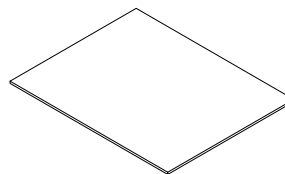

J. Side Drawer Panel 6pcs

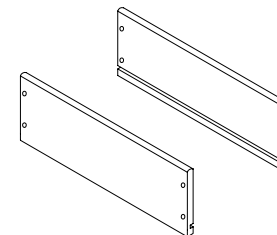

k. Front Drawer Panel 3pcs

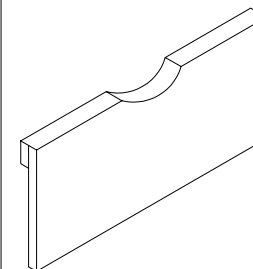

1. Machine Screw 12pcs x Large Screw

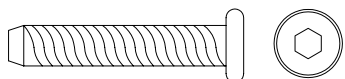

2. Plastic Lid 12pcs



3. Large Screw 18pcs
ø7 * 32mm

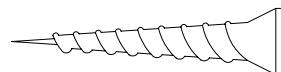

4. Allen Wrench 1pcs

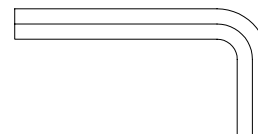

5. Wood Dowel 30*ø8 28pcs

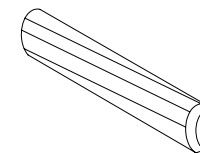

6. Medium Screw 24pcs
ø7 * 25mm



7. Small Screw 18pcs
ø7 * 12mm



8. Plastic Drawer Support 3pcs

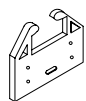

9. Plastic Drawer Frame
-Left&Right 3Sets



10. Plastic Drawer Stop 3pcs

